

$10+6+3=19$

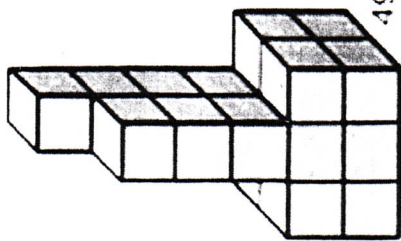

Седм HB-5

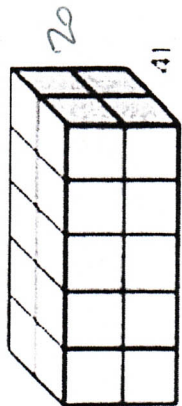
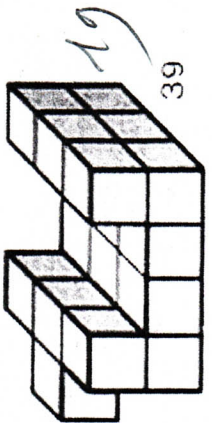
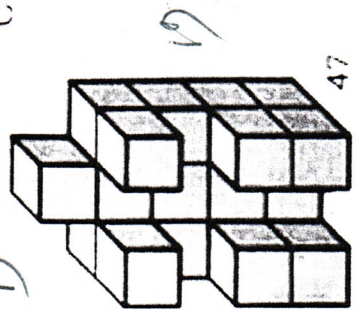
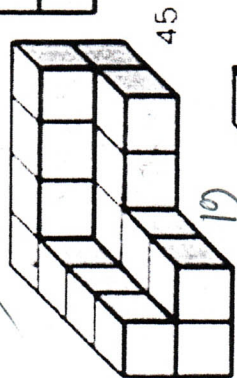
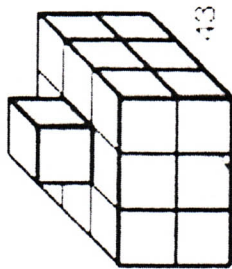

$(6 \times 4) + 3 = 27$

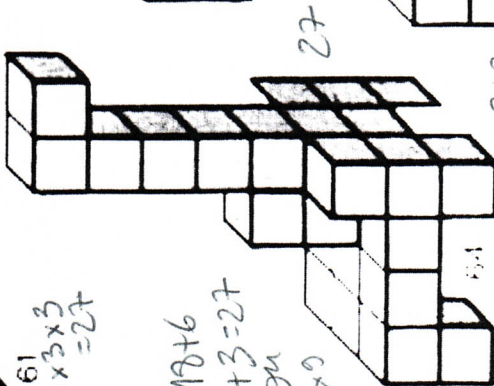
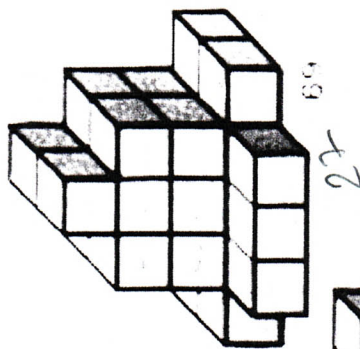
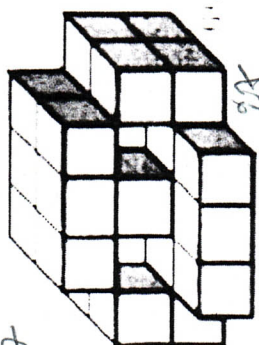
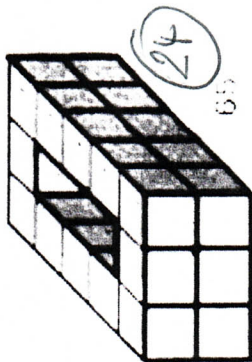
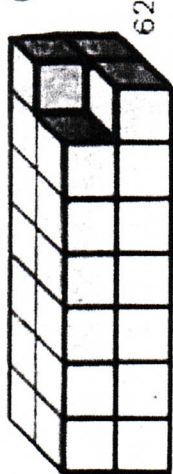

$4+12+4+2+3+2=27$

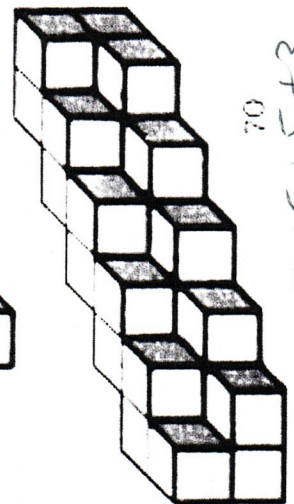
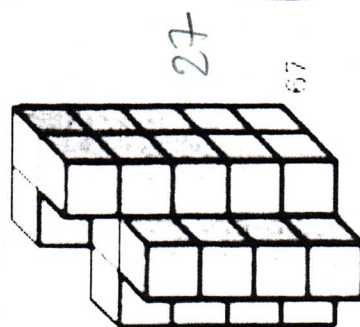

$4+5+5+5+5+3=27$

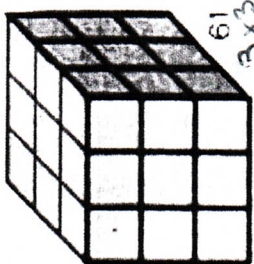

$3 \times 3 \times 3 = 27$

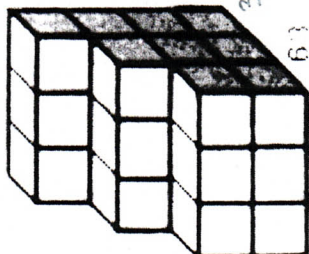

$18+6+3=27$

$3 \times 9 = 27$

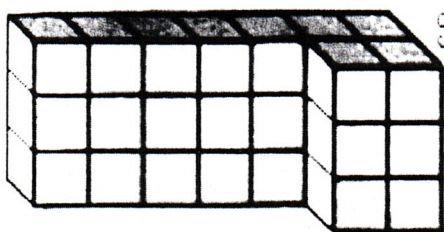

27

Седм HB-7

Il y peu de réponses différentes...